

JMS-30-MDT

Mobile Diesel Track Dust Collector

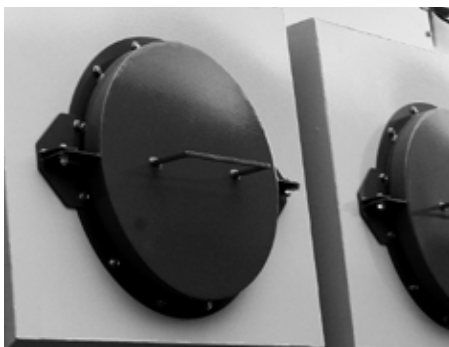



Grydale

Original Equipment Manufacturer (OEM) of fixed and mobile dust collection equipment

Health and Safety. Driving Demand for Effective Dust Control Solutions

Market demand for dust control solutions is increasing globally and Health and Safety experts are focusing on increasing dust control regulations due to the potentially hazardous consequences on health and safety of workers.

Dusts that can cause diseases when inhaled are found in a large number of industries. Hazardous dusts include but are not limited to: Asbestos, Crystalline Silica, Hard Metals, Aluminium, Bagasse, Cotton, Hay, Straw and Grains.

Workplace dust can be inhaled when the dust is created, usually when cutting, sanding, drilling or grinding, for example during demolition, construction or earthworks.

The risk of dust related diseases increases with increased exposure. Workplace Health and Safety legislation now places strict requirements for the management of dust through Workplace Exposure Limits (WEL). Globally, the WEL for specific dust types do vary, but regulations are being periodically reviewed and updated to take into account current scientific evidence linking exposure to disease.

Grydale JMS M-Series. Mobile Dust Collectors

Grydale JMS M-Series Dust Collectors are complete dust collection systems that feature a centrifugal exhaust fan, dirty air intake, patented drop out box, high efficiency filters, reverse pulse filter cleaning system, dust discharge system, clean air exhaust and fan silencer. All components are mounted on a single mobile base to create 6m³/s to 60m³/s of air flow.

Grydale JMS M-Series mobile dust collectors feature our proprietary technology that sets the units apart as pioneering dust collection solutions.

The JMS M-Series is a full range of mobile dust collection units. Units are available powered by diesel, electric or hybrid systems. A full range of mobility options are available including the internationally patented Track mounted units, Hydraulic Stepping Systems, Drag Skids, Trailer Mounted and Castor Wheel (Tow-able) units.

Mobility combined with compact integrated design provides significant advantages on construction sites.

In addition to the control of harmful dust, Grydale mobile dust collectors can also be used to recover valuable product in a range of industrial processes.



MINING



TUNNELLING



ABRASIVE
BLASTING



BULK STORAGE
HANDLING



SOURCE
EXTRACTION



CIVIL
CONSTRUCTION

Grydale mobile dust collection units are being used to manage dust and fume exposures within a wide range of industries.

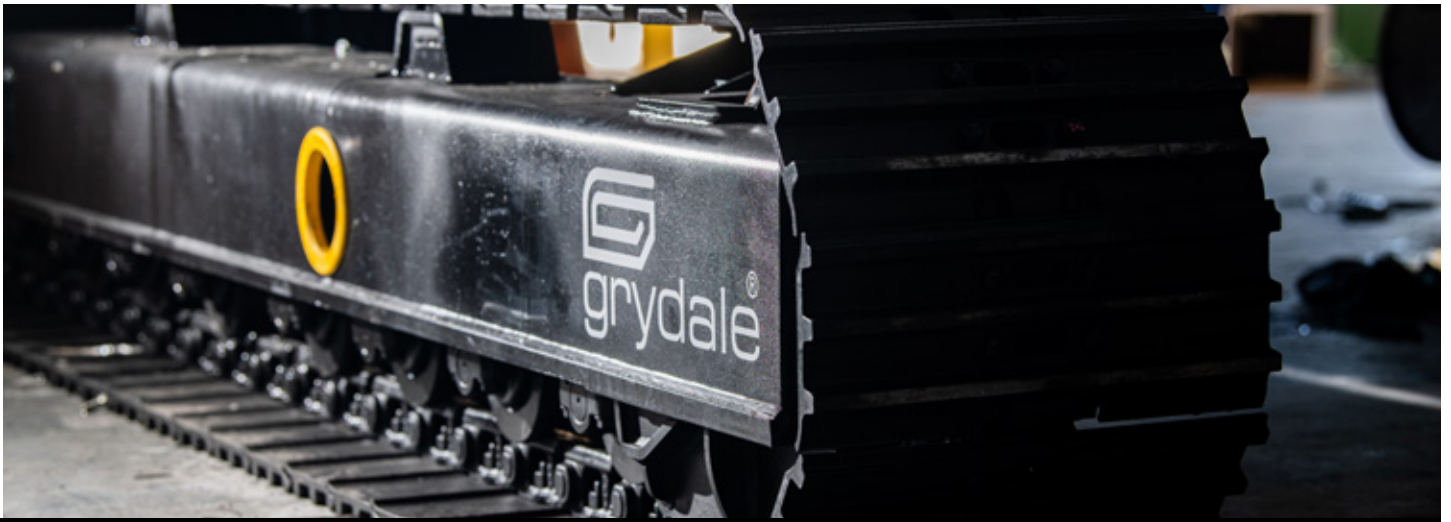

JMS-30-MDT

Internationally patented track mounted mobile dust collector

Overview

The **JMS-30-MDT** (Mobile, Diesel, Track) is a complete dust collection system mounted on a compact, track base. It features a centrifugal exhaust fan to create **30m³/s -3kPa**.

Mobility

Grydale hold international patents for manufacturing the only self-propelled dust collector on tracks on the market.

The Grydale **JMS-30-MDT** is mounted on a 11T track undercarriage to offer full mobility and better control with variable speeds between 2–4k.p.h. to increase the speed and efficiency of operations.

Track units are able to move and operate alongside excavation equipment to provide effective dust collection at source where mobility and maneuverability is key.

Remote Control Operation

The **JMS-30-MDT** is driven using remote control. Corded control will also be provided as a fail-safe.

Diesel Power

The **JMS-30-MDT** uses a T4F/T5 Volvo Penta Diesel Engine to power the hydraulic triple pump assembly driving the centrifugal exhaust fan, tracks, auger, rotary valve discharge system and screw compressor

Volvo Penta are the world leader in emission technology and meet the highest standards in the world for emissions. They are also designed to be reliable in extreme conditions with heavy-duty cooling, wiring and air filter technology.

Air Intakes

The **JMS-30-MDT** features flexible intake options which means that it can be used as a general ventilation machine or for source extraction. Flexible couplings allow the dirty air intake to connect effectively to ducting on uneven surfaces.

- The single 1372mm Ø air intake is best suited when there are large dust volumes.
- Additional 4 x 508mm Ø side air intakes can provide spot dust extraction from multiple sources.

Filters

32 High efficiency filter cartridges provide filtration of both dust and diesel particulates. Baffle plates distribute air throughout the dust collector ensuring an even wear of filters.

Filtration Efficiency

Independent, NATA certified Air Flow Performance and Filtration Testing has been conducted both above and below ground as part of rigorous Performance Verification and Certification processes and shows a collection efficiency of 99.99% at 0.067 micron.

Filter Maintenance

The filters can be easily accessed through the four filter access doors to allow efficient filter maintenance to maximise machine uptimes.

Changing the filters at the optimum time ensures the dust collector does not draw more kW than required to maintain air flows.

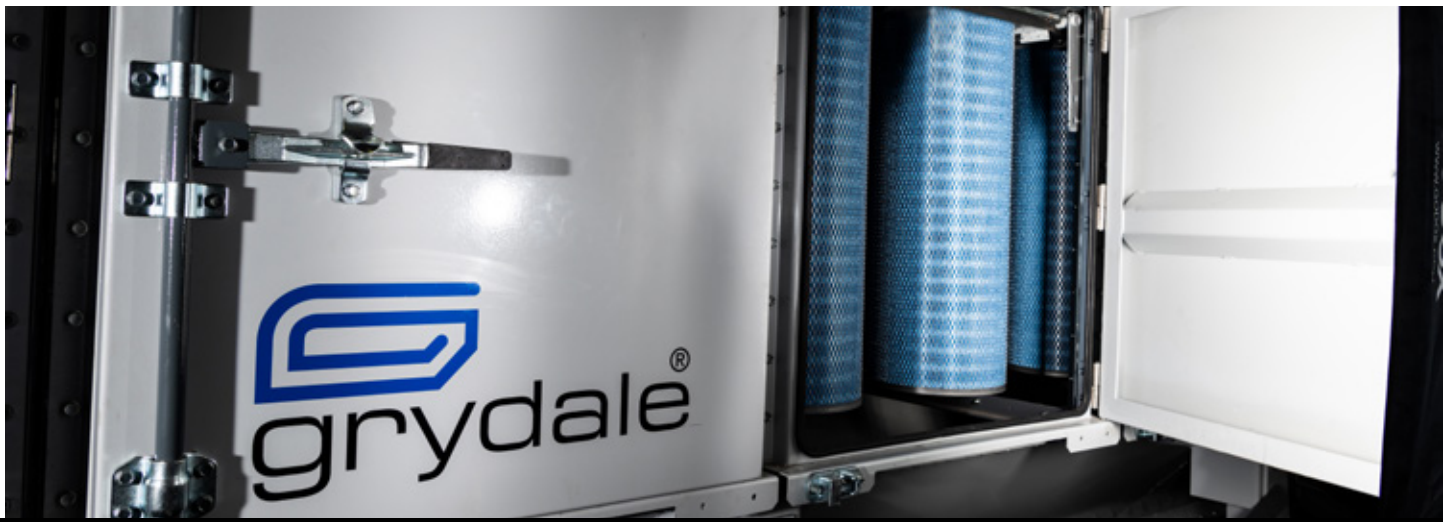

Key Features

NATA certified air flow performance and filtration tested

Reverse Pulse Cleaning System

The **JMS-30-MDT** features an on-board compressor, used for the reverse pulse filter cleaning system.

Jet tubes direct air inside the filters which blasts air from the inside of each filter, effectively removing dust build-up and preventing the filters from clogging. The adjustable timer allows the pressure and frequency of pulse cleaning to be set to the application and dust loading. This reduces the number of filter changes required.

Configuration option: A plant air attachment kit can also be fitted to the unit if there is air supply on-site.

Centrifugal Fan

Centrifugal fans offer superior energy efficiency and enhanced durability, allowing them to operate in even the most corrosive environment. The standard configuration for the **JMS-30-MDT** features a centrifugal fan to provide **30m³/s at -3kPa** using one motor and one impeller to develop system pressure.

Fan Silencer

Exhausted air passes through curved silencers to reduce noise pollution. Units can be supplied with a square to round attachment allowing a vent bag to be attached to the exhaust side if required.

Configuration option: Custom exhaust silencers can be designed and manufactured to meet site acoustic requirements.

Dust Discharge System

The standard configuration for the **JMS-30-MDT** includes a hydraulic reversible front facing auger and stainless steel rotary valve dust discharge system. The auger discharges dust particles to the site floor.

The use of hydraulics to power the augers and rotary valves maximises their efficiency whilst the ability to reverse the augers and force material through clean out hatches is key to increasing uptime in the event of product build up in the hopper and auger. This reduces the maintenance effort and the requirement to have LV and HV electricians servicing a mechanical component.

Configuration options: A front or side facing incline auger can be configured to discharge product to 1T bulker bags if required.

Programmable Logic Computer (PLC) with HMI Interface

A simple one button start-up / shut-down sequence starts / stops all critical components in a programmed order which increases the efficiency of the unit and provides additional safety for workers.

A 7" button dashboard display facilitates ease of operation. On-screen instructions and warnings display error codes which provide a powerful diagnostic tool to support service and maintenance staff.

Configuration option: There is the option to upgrade to a 12" touchscreen display.



Key Features

Sophisticated instrumentation combined with CANbus technology

CANbus System

The CANbus system enhances the speed, flexibility, and reliability in communication along with supporting effective troubleshooting and maintenance from off-site. The system retains key alarm logs so that system performance and troubleshooting can be undertaken as required.

Key instruments that use the CANbus system include:

RealTime Emissions Monitoring

Real time particle detectors examine emissions coming out of the clean air exhaust and can be tuned to meet the requirements of any given site. The unit can be programmed to alarm when levels are being approached and exceeded.

Static and Differential Pressure Gauges

The static pressure monitor alerts the operator if it is necessary to turn the system volume up due to a long duct run or if there's a blockage in the ducting. The differential pressure monitor alerts the operator if filters are blocked or if there are higher than normal dust loads.

Fuel Level Indicator Lights

Fuel level indicator lights alert the operator to remaining fuel levels.

Proximity Sensors

Configuration Option: When fitted, proximity sensors will alert the operator when any object becomes close to the unit when tracking.

Central Automatic Greasing System

Grease banks are fitted as standard to all units.

Configuration Option: An automatic greasing system can be fitted. This ensures all bearings are maintained at correct intervals, extending operational life and reducing the time required at service periods.

Safety Features

Grydale JMS M-Series Dust Collectors offer a number of features that focus on maximising the health and safety of workers along with providing a safe working environment by controlling dust and fumes. Key safety features on the **JMS-30-MDT** include:

Emergency Stop Lanyard System

One emergency stop button is located on the unit plus a safety lanyard system runs around the perimeter of the unit enabling anyone to 'grab and kill' the machine with immediate effect.

Split Starter and Battery Isolators

Split starter and battery isolators allow use of service lights when the engine is off or being maintained and also permit full machine diagnostics with no risk to service and maintenance staff.

Operation & Maintenance Lights

Operational and maintenance lights have been fitted in key locations on the unit giving operators and maintenance workers clear visibility of components and / or to illuminate working spaces.

Fire Suppression System

Configuration Option: To be compliant with current underground regulations, a fire suppression system can be added to surround the diesel engine.

Technical Specification

JMS-30-MDT

Overview

Air Volume	30m ³ /s
Power	Volvo Penta T4F/5 160kW Diesel
Fuel Tank	220L Diesel Fuel Tank 45L Adblue Fuel Tank
Mobility	Track Mounted with Remote Control Operation
Fabrication	3mm & 5mm Mild Steel International Two Pack Paint
Air Intake Ø	1 x 1372mm plus 4 x 508mm Ø

Filter Technical Data

Air Volume	30m ³ /s
Number of High Efficiency Filters	32
Filter Cleaning Efficiency	99.99% at 0.067 micron
Total Filter Surface Area	896m ²
Filter Temperature Limit	82°C (179.6°F)
Method of Changing Filters	Via 4 Filter Doors
Estimate Filter Change Time	Two technicians x 2hrs
Pre-Cleaning of Air Prior to Hitting Filters	Yes - Via Patented Drop Out Box

Centrifugal Fan

Maximum Pressure Drop Across Filters	-3kPa *
Variable Air Flow Control	Yes
Fan Silencer	Yes Option: to supply square to round attachment to allow vent bag to be attached to exhaust

Reverse Pulse Cleaning System

Reverse Pulse Cleaning Solenoids	16
On-board Compressor	Yes - 37 CFM Compressor
Plant Air Attachment	Optional Extra
Adjustable Pressure & Frequency Rate	Yes
Auto Drains	Yes



Discharge System

Hydraulic Reversible Auger	1
Main Screw Conveyor Auger	1 - Front Discharge
Incline Screw Conveyor Auger	Option: Front or Side Incline Discharge
Stainless Steel Rotary Valves	1

Instrumentation

PLC	Yes
HMI	7" Touch Button Display Option: 12" Touchscreen Display
Control System	CANBus
Static & Differential Pressure Gauges	Yes
Emissions Monitoring Probe	Yes - 24V
Operational Lights & Alarms	Yes
Work Safety Lights	12 x 24VDC Lights
Fuel Level Indicator Lights	Yes
Amber Rotating Beacons	2
Velocity Probe	No
Proximity Sensors	Optional Upgrade
Auto Greasing System	Optional Upgrade

Safety Features

Risk Assessment	Available on Request
Emergency Stops	1 E-Stop plus Safety Lanyard System Around the Perimeter
Amber Rotating Beacons	2
Split Isolators	Split Starter and Battery Isolator
Fire Suppression System	Optional Upgrade

* Alternative centrifugal fans can be utilised to optimise air volume and pressure to suit site conditions and specific applications.

Technical Specification

JMS-30-MDT

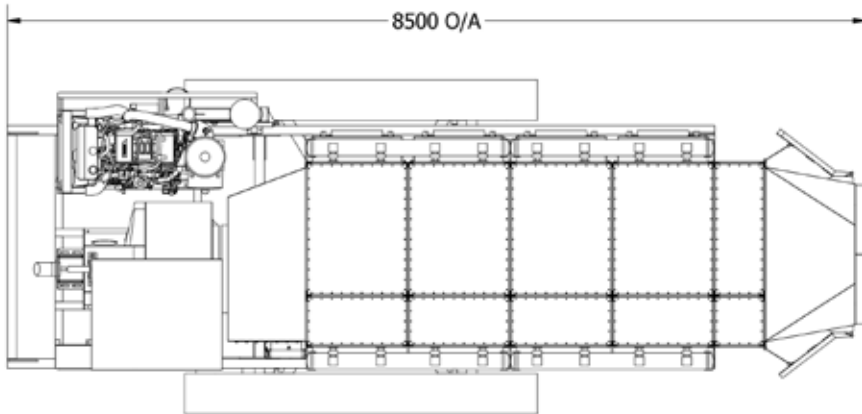

TOP VIEW

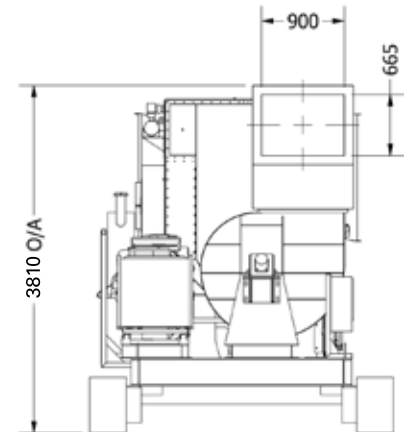

LEFT VIEW

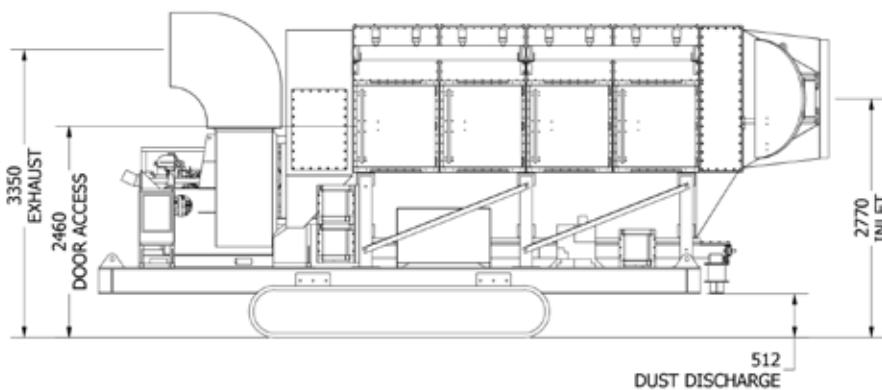

FRONT VIEW

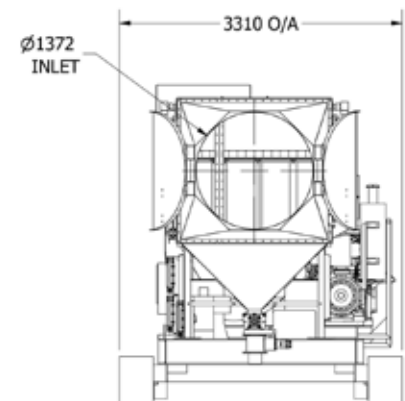

RIGHT VIEW

Key Dimensions

Maximum Height	3810mm
Maximum Width	3310mm
Maximum Length	8500mm
Mass	12T

Other models in the JMS 30 M-Series

30m³/s air volume, available as:

- **JMS-30-MDT** (Standard) - mobile, diesel, skid dust collector
- **JMS-30-MDS** - mobile, diesel, skid dust collector
- **JMS-30-MES** - mobile, electric, skid dust collector

Grydale. Experts in Dust Control

Our team have over 15 years' experience designing and manufacturing industrial dust collection and extraction solutions. We focus on adding value through a total service offering, providing ventilation design, manufacture, implementation, ongoing project management and on-site maintenance and technical support. **Contact us** for more information.



Grydale USA LLC.
Part of the Grydale Group Pty Ltd

14900 Interurban Avenue South,
Ste. 271 PMB #88,
Seattle WA 98158
+1 1888 479 3153
enquiries@grydaleusa.com
www.grydaleusa.com
UBI: 604 725 936

Grydale Canada Ltd.
Part of the Grydale Group Pty Ltd

4211 Prospect Road,
North Vancouver, BC V7N 3L6
+1 (778) 897 2229
enquiries@grydalecanada.com
www.grydalecanada.com.au
Company Number: 126402-2